





Job Name/Title: \_\_\_\_\_ Catalog Number \_\_\_\_\_

Contractor: \_\_\_\_\_ Notes: \_\_\_\_\_

## LED Outdoor Non-Cutoff Wall Pack SPEC SHEET

### GENERAL SPECIFICATIONS

**Voltage:** 120-277VAC, 60Hz  
**Average Rated Life:** 100K hours (L85) @ 77°F ambient\*  
**CRI:** 80  
**CCT:** 5000K  
**Ambient temp:** -22°F to 112°F  
**Power Factor:** >0.9  
**THD:** <20%  
**Surge protection:** 6kV  
**IES Distribution:** Type IV  
**LED Chip Type:** Samsung 2835  
**IP Rating:** IP65 Wet location  
**Driver:** Sosen high power

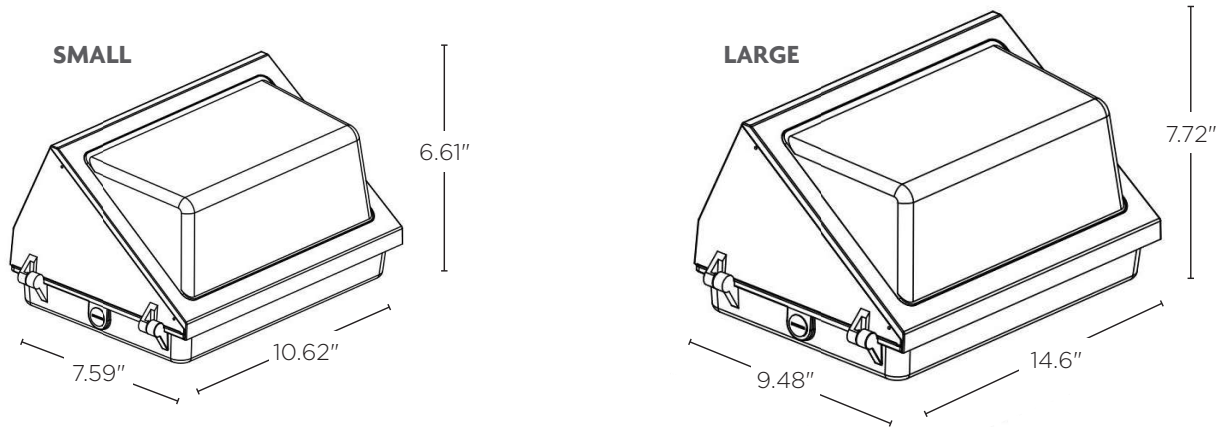

### SPECIFICATIONS / ORDER INFO

Item Number	Product Code	UPC	Input Amps	Wattage	DLC ID	DLC Lumens	DLC LPW	Equivalent HID	PK QTY
<b>SMALL WALL PACK</b>									
F-WP-28W/50K/BZ/HE	74491	751338029088	340mA	28	PLJXPUCYRNTP	3,640	130	100W	1/4
F-WP-40W/50K/BZ/HE	74493	751338029095	490mA	40	PLOGTXC3TK8S	5,540	139	150W	
<b>LARGE WALL PACK</b>									
F-WP-50W/50K/BZ/HE	74495	751338029101	610mA	50	PLB1O8R42MVI	7,065	141	175W	1/4
F-WP-60W/50K/BZ/HE	74497	751338029118	730mA	60	PLCUC9CKHISB	8,280	138	250W	1/4
F-WP-100W/50K/BZ/HE	74498	751338029125	1200mA	100	PLHW8AG2V00J	14,400	144	320W	1/4
F-WP-120W/50K/BZ/HE	74499	751338029132	1471mA	120	PL2KQ4RHE1YT	16,945	141	400W	1/4
<b>LARGE WALL PACKS WITH EMERGENCY BACKUP</b>									
F-WP-40W/50K/BZ/EM	74524	751338029316	490mA	40	PLOGTXC3TK8S	5,540	139	150W	1/4
F-WP-50W/50K/BZ/EM	74525	751338029347	610mA	50	PLB1O8R42MVI	7,065	141	175W	1/4
F-WP-60W/50K/BZ/EM	74526	751338029408	730mA	60	PLCUC9CKHISB	8,280	138	250W	1/4
F-WP-100W/50K/BZ/EM	74528	751338029439	1200mA	100	PLHW8AG2V00J	14,400	144	320W	1/4
F-WP-120W/50K/BZ/EM	74529	751338029453	1471mA	120	PL2KQ4RHE1YT	16,945	141	400W	1/4

### NOMENCLATURE

Example: **F-WP-40W/50K/BZ/EM**

F=Fixture / WP=Wall Pack / 40=40 Watts / 50K=5000K CCT / BZ=Bronze Finish / EM=Emergency Backup  
 HE=High Efficiency

\*50K hours (L70) @ 45°C (112°F) ambient. Specifications subject to change without notice.

This device complies with Part 15 of the FCC Rules. Operation is subject to the following two conditions: (1) this device may not cause harmful interference, and (2) this device must accept any interference received, including interference that may cause undesired operation. Fixture may not be compatible with all dimmers.

## LED Outdoor Non-Cutoff Wall Pack SPEC SHEET

### 28W

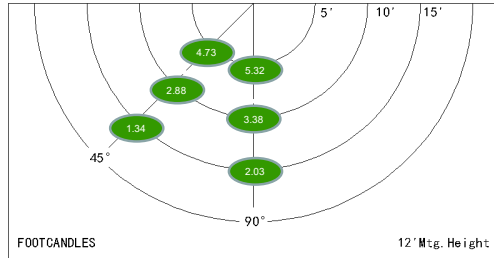

WALL PACK FOOTCANDLES ON THE GROUND							
Mtg. Hgt.	90°			45°			Avg. FCs 450 sq. Ft.
	5'	10'	15'	5'	10'	15'	
12'	5.32	3.38	2.03	4.73	2.88	1.34	3.28
14'	4.05	2.57	1.93	3.52	1.85	1.11	2.51
30'	0.68	0.49	0.31	0.49	0.33	0.20	0.42

### 40W

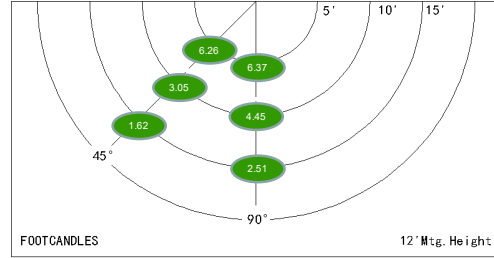

WALL PACK FOOTCANDLES ON THE GROUND							
Mtg. Hgt.	90°			45°			Avg. FCs 450 sq. Ft.
	5'	10'	15'	5'	10'	15'	
12'	6.37	4.45	2.51	6.26	3.05	1.62	4.04
14'	4.95	4.01	2.26	4.82	2.74	1.46	3.37
30'	0.91	0.80	0.61	0.77	0.47	0.29	0.64

### 50W

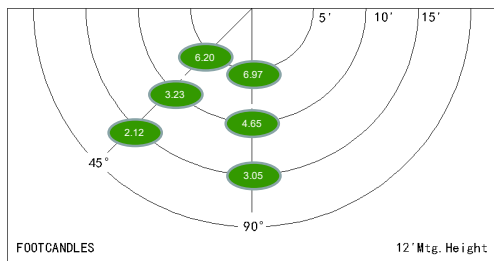

WALL PACK FOOTCANDLES ON THE GROUND							
Mtg. Hgt.	90°			45°			Avg. FCs 450 sq. Ft.
	5'	10'	15'	5'	10'	15'	
12'	6.97	4.65	3.05	6.20	3.23	2.12	4.37
14'	5.05	4.65	2.56	4.50	3.08	1.65	3.58
30'	1.28	1.01	0.80	1.02	0.82	0.56	0.92

### 60W

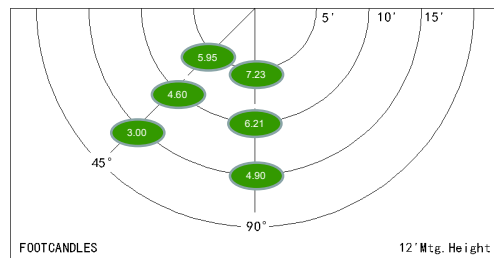

WALL PACK FOOTCANDLES ON THE GROUND							
Mtg. Hgt.	90°			45°			Avg. FCs 450 sq. Ft.
	5'	10'	15'	5'	10'	15'	
12'	7.23	6.21	4.90	5.95	4.60	3.00	5.30
14'	5.03	4.65	3.90	4.01	3.60	2.90	4.10
30'	1.43	1.27	0.98	1.40	1.03	0.60	1.12

### 100W

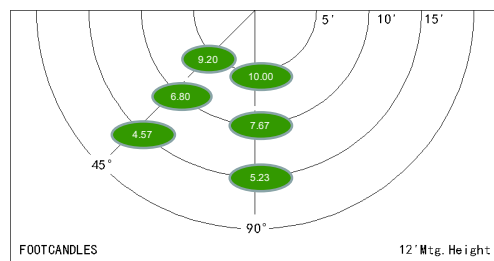

WALL PACK FOOTCANDLES ON THE GROUND							
Mtg. Hgt.	90°			45°			Avg. FCs 450 sq. Ft.
	5'	10'	15'	5'	10'	15'	
12'	10.00	7.67	5.23	9.20	6.80	4.57	7.20
14'	9.02	6.03	4.05	8.29	5.18	3.66	6.03
30'	2.87	2.34	1.75	2.43	1.54	0.94	1.98

### 120W

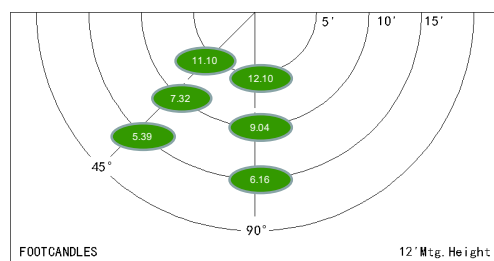

WALL PACK FOOTCANDLES ON THE GROUND							
Mtg. Hgt.	90°			45°			Avg. FCs 450 sq. Ft.
	5'	10'	15'	5'	10'	15'	
12'	12.10	9.04	6.16	11.10	7.32	5.39	8.52
14'	9.74	7.67	5.23	8.79	6.87	4.57	7.14
30'	3.30	2.80	2.20	2.93	2.28	1.46	2.50